

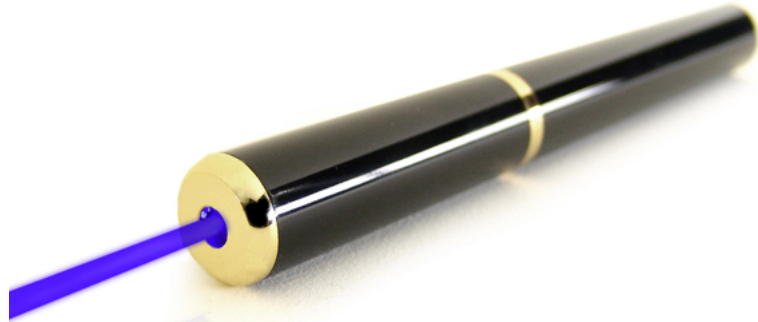

Hydra Blue Laser Pointer



Overview:

Cutting-edge 447 nm laser diode technology is what makes this blue laser pointer both unique and affordable. Keep everyone's attention with the Hydra's deep blue light. This

Key Features:

- *Starting at: \$279*
- *Output Power: 2 mW - 4.99 mW (Varies with model)*
- *Expected Life: 5000 hours*
- *Wavelength: 447 nm (blue)*
- *Key Feature: Cutting-edge laser diode technology in an affordable blue laser pointer!*
- *Package Includes: Laser pointer, aluminum carrying case, instructions/warranty.*
- *Casing: Piano-black finished Brass with gold accents*
- *Safety Info: Complies with Class IIIa regulations*
- *Duty Cycle: 100%*

Specifications:

This spec sheet has been generated specifically for part number GHP-GAP, per your request, and data for the entire series is also displayed for your reference. The specs which are specific to GHP-GAP have been highlighted below in **red + bold**.

Laser Form Factor	GAP
Output Power (mW)	<5
FDA Safety Class	IIIa
Divergence (mrad, full angle)	<1.5
Beam Dimensions (mm, 1/e ²)	5
Longitudinal Modes	Multiple
Approximate Peak Power (W)	5
Storage Temperature Range (°C)	-10 to 50
Total Power Consumption (W)	1
Max. Power Input Duty Cycle	100%
Cooling Method	Passive Air
Standard Warranty (months)	6
MTTF (operational hours)	5000
Weight of Laser Head (kg)	0.1
Laser Head Dimensions (mm)	150 (l) x 16.5 (d)
Power Supply	2 x CR2 Batteries

CW: All specifications are based on performance at full output power and after the specified warmup period. Output characteristics may change if the laser is run at a different power level.

Q-Switched: Specifications are based on the laser pulsing at the specified design frequency. Output characteristics may change if the laser is run at a different frequency.

Regulatory Classification:

The model you have selected (GHP-GAP) requires the following safety label(s):

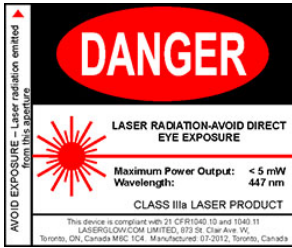

Dimensional Drawing - Laser Form Factor: GAP:

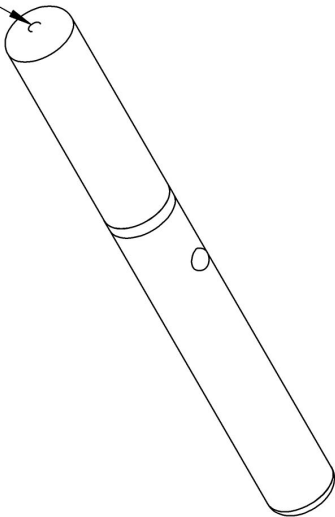
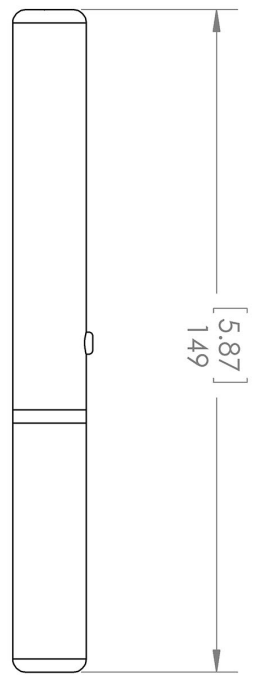
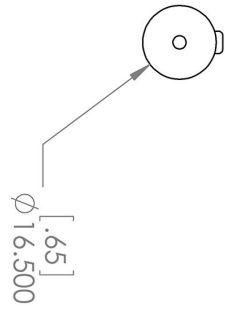
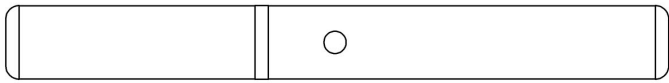

Aperture

UNLESS OTHERWISE SPECIFIED:
 DIMENSIONS ARE IN MM(INCH)
 TOLERANCES: +/- 0.75 MM

THE INFORMATION CONTAINED IN THIS
 DRAWING IS THE SOLE PROPERTY OF
 LASERGLLOW TECHNOLOGIES. ANY
 REPRODUCTION IN PART OR AS A WHOLE
 WITHOUT THE WRITTEN PERMISSION OF
 LASERGLLOW TECHNOLOGIES IS
 PROHIBITED. © 2012 LASERGLLOW.COM
 LIMITED. ALL RIGHTS RESERVED

Laserglow Technologies



TITLE:
**Aquarius /
 Rigel HV /
 Electra / Hydra**
 REV
1

SCALE: 2:3

SHEET 1 OF 1

Accessories:

The most popular accessories for model GHP-GAP are shown below. For additional details regarding these or other accessories please see our website or contact us directly.

Part Number	Description	
 AGF5327XX	LSG-532-NF-7 Fit-Over Safety Goggles 532nm Output: OD 7+ at 190-532 nm CE Certified Full Details: www.laserglow.com/AGF	
 ACAGAQ1XX	Carrying Case-7 Aquarius/Electra/Rigel HV/Hydra Full Details: www.laserglow.com/ACA	Included With Laser

FOR MORE INFORMATION PLEASE CONTACT:

LASERGLOW TECHNOLOGIES
873 St. Clair Ave West, Toronto, ON, Canada M6C1C4
Tel. (416) 729-7976 Fax (480) 247-4864
sales@laserglow.com www.laserglow.com

E&OE: Data included in this sheet may be subject to change without notice.

Please confirm critical specifications with our staff prior to ordering.