

LES-520 Brightline PRL Line- Projecting Laser

Laserglow Part Number: ELH040267

Similar Products:

For information about the other lasers in this product family visit:

<http://www.laserglow.com/ELH>

Ordering:

Order Online Now or Request Quote:

<http://www.laserglow.com/ELH040267>

Series Specifications:

Nominal Wavelength	520 nm
Output Type	CW
Laser Source Type	Diode

Overview:

With most green lasers, the beam may exit the laser at a slight angle. The Brightline PRL series features an adjustable beam angle, so you can set the laser beam to be parallel to the body. This way, the laser body can be used as your alignment reference. In addition, green lasers are four to five times more visible to the human eye than red lasers of the same output power, making the Brightline PRL Green lasers a versatile alignment solution under any lighting conditions. These products are often used for shaft alignment or the alignment of rotating machinery.

Key Features:

- *Starting at:* \$429
- *Expected Life:* 3000-5000 hours
- *Projection Type:* Line
- *Key Feature:* Beam is steerable relative to housing. Can be made parallel to better than 0.1°.
- *Package Includes:* Alignment laser mounted in block (mounting bracket and power supply optional)
- *Casing:* Machined Aluminum

Image Coming Soon!

Specifications:

This spec sheet has been generated specifically for part number ELH040267, per your request, and data for the entire series is also displayed for your reference. The specs which are specific to ELH040267 have been highlighted below in **red + bold**.

Laser Form Factor	B9
Output Power (mW)	5, >20, >40 , >60
IEC Safety Class	3R
Projection Type (See below for detail)	Line
Projection Fan Angle (°, full angle)	30
Divergence (mrad, full angle)	<0.3
Beam Dimensions (mm, 1/e ²)	3
Longitudinal Modes	Multiple
IP rating	67
Storage Temperature Range (°C)	-10 to 50
Max. TTL Modulation Freq. (Hz)	500
Modulation Input Signal	0-5 VDC
Cooling Method	Passive Air
Standard Warranty (months)	6
MTTF (operational hours)	10000
Weight of Product or Laser Head (kg)	0.26
Dimensions of Product or Laser Head (mm)	68 (l) x 20 (d)
Power Supply	3-6 VDC input

CW: All specifications are based on performance at full output power and after the specified warmup period. Output characteristics may change if the laser is run at a different power level.

Q-Switched: Specifications are based on the laser pulsing at the specified design frequency. Output characteristics may change if the laser is run at a different frequency.

Power Supply Options:

The Brightline Premium series of alignment lasers accept direct DC input of 3 to 6 VDC. The power connector is a 5.5 mm OD, 2.1 mm ID DC Barrel Jack (center pole positive), but non-waterproof connectors are compatible. If you do not want to provide DC current directly, we recommend that you use our AC power supply. The model number for the standard North American AC Power Supply is ABF05AWXX and you can find complete details here:

www.laserglow.com/ABF.

Projection Types:

The following projection types are available for this laser series.

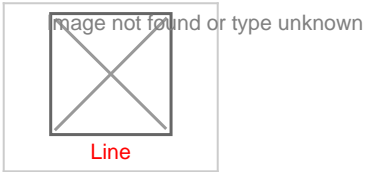

Regulatory Classification:

The model you have selected (ELH040267) requires the following safety label(s):



LASERGLOW.COM LIMITED, 873 St. Clair Ave W, Toronto, ON, Canada M6C 1C4

Dimensional Drawing - Laser Form Factor: B9:





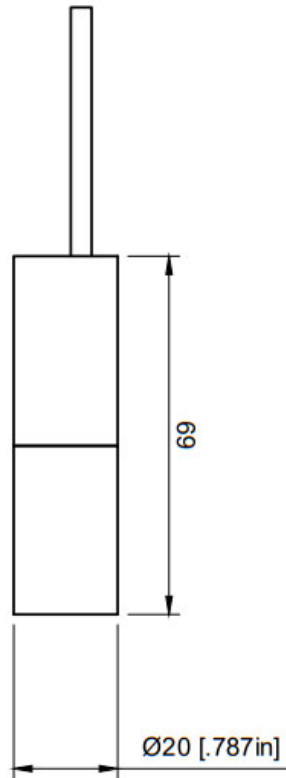
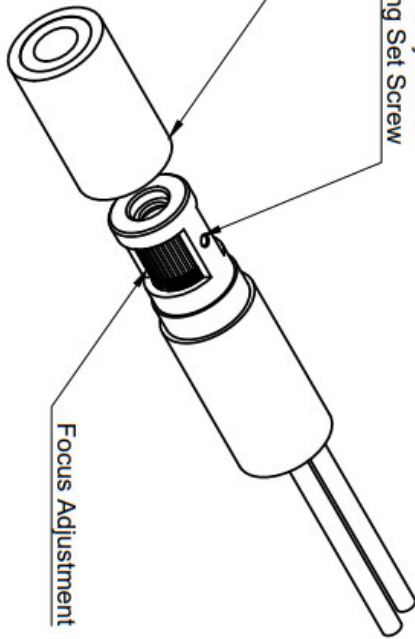

Remove front cap to
access focus adjustment



Title	
Brightline Premium	
Laserglow Technologies	
Dimensions are in mm [inch]	
The information contained in this drawing is the sole property of Laserglow Technologies. Any reproduction in part or as a whole without the written permission of Laserglow Technologies is Prohibited.	
Rev.	

Accessories:

The most popular accessories for model ELH040267 are shown below. For additional details regarding these or other accessories please see our website or contact us directly.

Part Number	Description	
 ADB000XXX	ADB-deluxe Brightline Deluxe Mounting Bracket Full Details: www.laserglow.com/ADB	
 ABB000XXX	ABB-standard Brightline Standard Mounting Bracket Full Details: www.laserglow.com/ABB	
 ABF05A3WX	ABF-N.American Brightline Premium 5V Power Supply (80-260 VAC, N. American plug) 3A w/WP connector For Brightline Premium Only Full Details: www.laserglow.com/ABF	
 ABLATTXXX	Brightline Attenuator c/w Optics Full Details: www.laserglow.com/ABL	

FOR MORE INFORMATION PLEASE CONTACT:

LASERGLOW TECHNOLOGIES
873 St. Clair Ave West, Toronto, ON, Canada M6C1C4
Tel. (416) 729-7976 Fax (480) 247-4864
sales@laserglow.com www.laserglow.com

E&OE: Data included in this sheet may be subject to change without notice.

Please confirm critical specifications with our staff prior to ordering.