

LCS-0532 Low-Cost DPSS Laser System



Series Specifications:

Nominal Wavelength	532 nm
Output Type	CW
Laser Source Type	DPSS

Overview:

The LCS-0532 Series of Diode-Pumped Solid-State (DPSS) Lasers are ideal for applications requiring up to 200 mW of 532 nm laser light at the lowest cost possible while maintaining high quality and a long operating life.

These lasers are commonly used for general illumination and fluorescence excitation. The driver is available as a complete FDA-compliant system or as an O.E.M. component with significantly reduced dimensions.

Laserglow products are currently being used by some of the World's top universities and other prominent research facilities.

Key Features:

- Air cooled - no need for water cooling or external chiller
- Lightweight, compact design
- Efficient DPSS technology runs on standard AC power (85 - 264 V, 47 - 63 Hz)
- Also available in 5/12 VDC power supply
- >5,000 hours continuous maintenance-free operating life
- 6 month warranty
- TTL modulation
- FDA CDRH Compliant Class IIIb / Class IV enclosure
- 48-hour replacement coverage available for an additional fee on specific models

Package Includes:

- Laser Head
- Driver/Power Supply
- Power Cable
- Detachable TTL wires (on applicable models)
- Keys, Safety Interlock (FDA power supplies only)
- Hard-shell Carrying Case

Specifications:

This spec sheet has been generated specifically for part number C53-C, per your request, and data for the entire series is also displayed for your reference. The specs which are specific to C53-C have been highlighted below in **red + bold**.

Laser Form Factor	C	D
Output Power (mW)	>15, >35, >50	>80, >100
Output Power Stability (%RMS/4h)	<5, <10	<5, <10
FDA Safety Class	IIIb	IIIb
Central Wavelength (nm)	531.65	531.65
Wavelength Tolerance (+/- nm)	1	1
Divergence (mrad, full angle)	<1.2	<1.2
Beam Dimensions (mm, 1/e ²)	1.5	1.5
Transverse Mode	TEM00	TEM00
Longitudinal Modes	Multiple	Multiple
Warm-up Time (minutes)	10	10
Optical Noise Amplitude (%RMS @ 20 Hz - 20 MHz)	<20	<20
M ²	<1.48	<1.48
Beam Pointing Stability (mrad)	<0.05	<0.05
Operating Temperature Range (°C)	10 to 35	15 to 35
Storage Temperature Range (°C)	-10 to 50	-10 to
Max. TTL Modulation Freq. (Hz)	10000	10000
Modulation Input Signal	0-5 VDC	0-5 VDC
Total Power Consumption (W)	10	35
Max. Power Input Duty Cycle	100%	100%
Cooling Method	Forced Air	Forced Air
Standard Warranty (months)	6	6
MTTF (operational hours)	5000	5000
Weight of Product or Laser Head (kg)	0.2	0.2
Beam Height from Base Plate (mm)	15	15

CW: All specifications are based on performance at full output power and after the specified warmup period. Output characteristics may change if the laser is run at a different power level.

Q-Switched: Specifications are based on the laser pulsing at the specified design frequency. Output characteristics may change if the laser is run at a different frequency.

Specifications Page 2:

Laser Form Factor	C	D
Dimensions of Product or Laser Head (mm)	77 (l) x 30 (w) x 30 (h)	87 (l) x 40 (w) x 40 (h)

CW: All specifications are based on performance at full output power and after the specified warmup period. Output characteristics may change if the laser is run at a different power level.

Q-Switched: Specifications are based on the laser pulsing at the specified design frequency. Output characteristics may change if the laser is run at a different frequency.

Power Supply Options:

These lasers are available with several different power supply options. The model that you have selected is highlighted below, and any other options are shown for easy reference.

	Power Supply Type:	OC	OD
OEM AC 	Input Power	85v to 264v	85v to 264v
	Power Supply Weight (kg)	0.14	0.14
	Dimensions (mm)	90 (l) x 47 (w) x 37 (h)	90 (l) x 47 (w) x 37 (h)

	Power Supply Type:	1C	1D
OEM 12 Volt DC 	Input Power	0v to 12v	0v to 12v
	Power Supply Weight (kg)	0.2	0.2
	Dimensions (mm)	115 (l) x 59 (w) x 34 (h)	115 (l) x 59 (w) x 34 (h)

	Power Supply Type:	SC	SD
FDA-Compliant Standard 	Input Power	85v to 264v	85v to 264v
	Power Supply Weight (kg)	1.2	1.2
	Dimensions (mm)	133 (l) x 130 (w) x 65 (h)	133 (l) x 130 (w) x 65 (h)

	Power Supply Type:	5D	5C
OEM 5 Volt DC 	Input Power	0v to 5v	0v to 5v
	Power Supply Weight (kg)	0.1	0.1
	Dimensions (mm)	110 (l) x 47 (w) x 30 (h)	110 (l) x 47 (w) x 30 (h)

	Power Supply Type:	DD
OEM 5/12 Volt DC 	Input Power	5v to 12v
	Power Supply Weight (kg)	0.2
	Dimensions (mm)	115 (l) x 59 (w) x 34 (h)

*Power supply may not be exactly as shown, see dimensional drawings on next 2 pages.

*Dimensions for fiber-integrated (l_) include laser head packaged inside.

Regulatory Classification:

The model you have selected (C53-C) requires the following safety label(s):

Image not found or type unknown

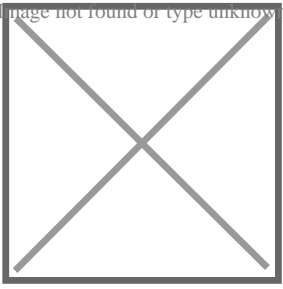

Dimensional Drawing - Laser Form Factor: C:

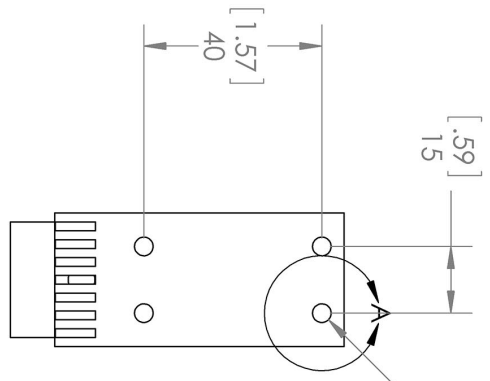
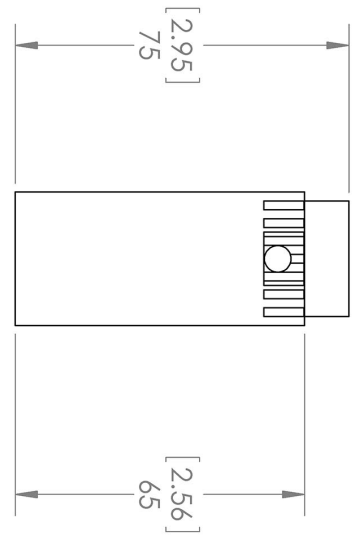
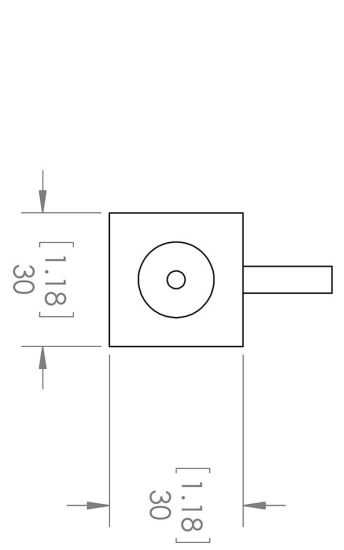

4X ϕ M4X0.7 TAPPED HOLE
 ∇ 5 [0.20]

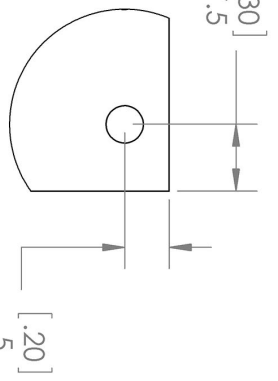

DETAIL A
 SCALE 4 : 3

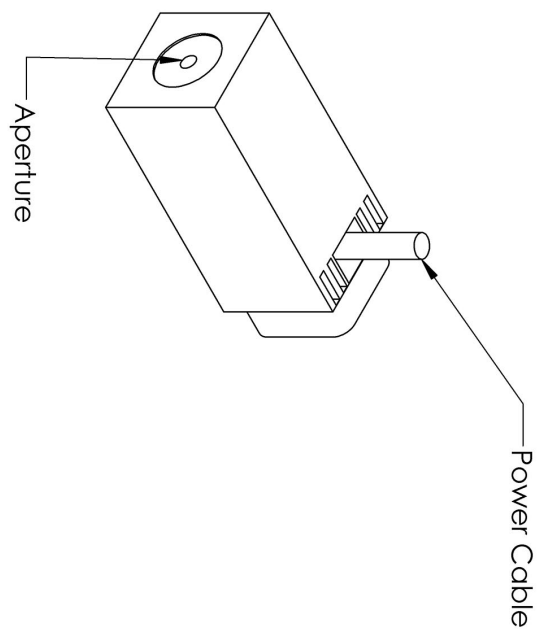
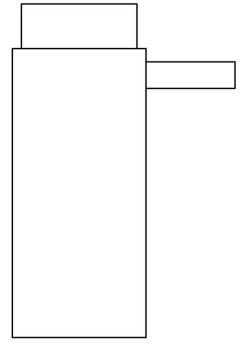

UNLESS OTHERWISE SPECIFIED:
 DIMENSIONS ARE IN MM(INCH)
 TOLERANCES: +/- 0.75 MM

THE INFORMATION CONTAINED IN THIS DRAWING IS THE SOLE PROPERTY OF LASERGLOW TECHNOLOGIES. ANY REPRODUCTION IN PART OR AS A WHOLE WITHOUT THE WRITTEN PERMISSION OF LASERGLOW TECHNOLOGIES IS PROHIBITED. © 2012 LASERGLOW.COM LIMITED. ALL RIGHTS RESERVED

TITLE: LAB/OEM "C" Housing	
TITLE: Loserglow Technologies	SCALE: 2:3
SCALE: 2:3	SHEET 1 OF 1

Dimensional Drawing - Power Supply Form Factor: OC:

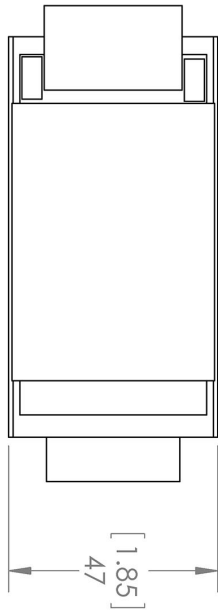
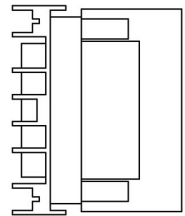
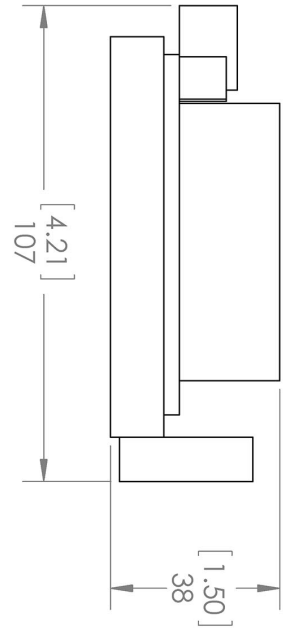

Output
(DB9 Connector
to laser)

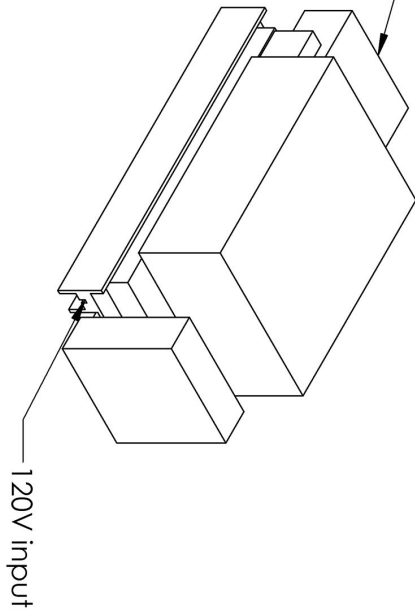

UNLESS OTHERWISE SPECIFIED:

DIMENSIONS ARE IN MM(INCH)
TOLERANCES: +/- 0.75 MM

THE INFORMATION CONTAINED IN THIS DRAWING IS THE SOLE PROPERTY OF LASERGLOW TECHNOLOGIES. ANY REPRODUCTION IN PART OR AS A WHOLE WITHOUT THE WRITTEN PERMISSION OF LASERGLOW TECHNOLOGIES IS PROHIBITED. © 2012 LASERGLOW.COM LIMITED. ALL RIGHTS RESERVED

Laserglow Technologies

TITLE:



**Power Supply
OC/OD/OG
REV 1**

SCALE: 2:3

SHEET 1 OF 1

Accessories:

The most popular accessories for model C53-C are shown below. For additional details regarding these or other accessories please see our website or contact us directly.

Part Number	Description	
 AGF5327XX	LSG-532-NF-7 Fit-Over Safety Goggles 532nm Output: OD 7+ at 190-532 nm CE Certified Full Details: www.laserglow.com/AGF	
 TBK	Complete optics kits with breadboard mounting hardware. External modulators, variable attenuators, free-space fiber launch systems Full Details: www.laserglow.com/TBK	

FOR MORE INFORMATION PLEASE CONTACT:

LASERGLOW TECHNOLOGIES
873 St. Clair Ave West, Toronto, ON, Canada M6C1C4
Tel. (416) 729-7976 Fax (480) 247-4864
sales@laserglow.com www.laserglow.com

E&OE: Data included in this sheet may be subject to change without notice.

Please confirm critical specifications with our staff prior to ordering.